





STORAGE RACKS

<p>FLOOR MOUNT POST PROTECTOR</p>  <p>Size 12" x 3/16" 18" x 3/16" 24" x 3/16"</p> <p>Catalog Number I5712-P I5718-P I5724-P</p>	<p>BOLT ON POST PROTECTOR</p>  <p>Size 12" x 1/4" 18" x 1/4" 24" x 1/4"</p> <p>Catalog Number I5812 I5818 I5824</p>	<p>ROW SPACER</p>  <p>Distance between upright frames (back to back) 6" 8" 12" 18"</p> <p>Catalog Number RSIN06 RSIN08 RSIN12 RSIN18</p> <p>Furnished with necessary bolts & nuts. Connects and rigidly holds racks at set spacing. Recommended when upright height is more than six times depth.</p>	<p>WATERFALL CROSSBAR</p>  <p>Upright frame depth 36" 42" 48"</p> <p>Catalog Number A1036G A1042G A1048G</p>
--	---	--	--

<p>PALLET STOP BEAM</p> 	<p>RACK GUARD</p> 	<p>WIRE DECK</p> 
---	---	--

Color Options

Standard Colors					Optional Colors*					
	PH01 Green	PH05 Orange	PH06 Blue**	PH02 Gray**		PH03 Beige*	PH04 White*	PH08 Red*	PH10 Yellow*	PH09 Black*
	** Paint up charge fee applies				*Minimum quantity and set up fee required					

High quality polyurethane paint. Environmentally safe, does not contain lead.
Standard colors: green uprights & orange beams (other colors available upon request see chart above).
Colors outside of the listed above are available, please contact inside sales for details.

Husky Rack and Wire makes continuous improvements in all its products. We reserve the right to change specifications without notice.

Warranty Information
For warranty information applicable to all our products, refer to the Husky Rack and Wire Terms and Conditions of Sale, which are accessible at www.huskyrackandwire.com/terms-conditions



IMP 23536



HUSKY
RACK & WIRE™

6146 Denver Industrial Park Circle • Denver, NC 28037
704-483-1900

www.huskyrackandwire.com



Item #80146-7



HUSKY
RACK & WIRE™



INVINCIBLE UPRIGHTS

INVINCIBLE BEAMS

UPRIGHT CAPACITIES

VERTICAL BEAM SPACING	ANSI MH 16.1 2012 UPRIGHT FRAME			
	IU18	IU24	IU29	IU35
36	21,450	29,410	39,040	46,140
42	19,880	27,490	36,280	42,770
48	18,160	25,390	33,290	39,130
54	16,350	23,170	30,170	35,360
60	14,510	20,890	27,010	31,550
66	12,690	18,600	23,870	27,800
72	10,960	16,330	20,800	24,150
78	9,540	14,280	18,100	20,950
84	8,370	12,570	15,870	18,330
90	7,390	11,140	14,010	16,160
96	6,570	9,930	12,460	14,340

- For vertical beam spacing greater than 96", please contact your distributor.
- Beam spacing (vertically) is measured from top of beam to top of beam starting from the floor to the top of the first beam and so on.
- Uprights and beams constructed of HSLA prime, U.S. made, high-strength steel. (Documented verification available on request).
- Standard baseplates are 4" x 4.25" x 0.13". Oversized baseplates available upon request.
- PE stamped drawings with calculations available for projects with permitting requirements.
- Capacities for static loads only
- Anchors must be provided per ACI-318 Appendix D
- Maximum upright height available is 45'. For more information on additional upright frame configurations please contact your Regional Manager or inside sales at 704-483-1900.

Capacity charts are presented only to aid in the design process. A rack system's capacity is determined by the methods set forth in the most recent version of ANSI MH16.1. Contact Husky Rack & Wire or your distributor for help with determining the capacity for your rack system.

DEPTH	HEIGHT	3" X 1-5/8" (14 GA)	3" X 3" (14 GA)	3" X 3" (13 GA)	3" X 3" (12 GA)
36"	96"	IU18360096	IU24360096	IU29360096	IU35360096
	120"	IU18360120	IU24360120	IU29360120	IU35360120
	144"	IU18360144	IU24360144	IU29360144	IU35360144
	168"	IU18360168	IU24360168	IU29360168	IU35360168
	180"	IU18360180	IU24360180	IU29360180	IU35360180
	192"	IU18360192	IU24360192	IU29360192	IU35360192
	240"	IU18360240	IU24360240	IU29360240	IU35360240
	288"	-	IU24360288	IU29360288	IU35360288
42"	96"	IU18420096	IU24420096	IU29420096	IU35420096
	120"	IU18420120	IU24420120	IU29420120	IU35420120
	144"	IU18420144	IU24420144	IU29420144	IU35420144
	168"	IU18420168	IU24420168	IU29420168	IU35420168
	180"	IU18420180	IU24420180	IU29420180	IU35420180
	192"	IU18420192	IU24420192	IU29420192	IU35420192
	240"	IU18420240	IU24420240	IU29420240	IU35420240
	288"	-	IU24420288	IU29420288	IU35420288
48"	96"	IU18480096	IU24480096	IU29480096	IU35480096
	120"	IU18480120	IU24480120	IU29480120	IU35480120
	144"	IU18480144	IU24480144	IU29480144	IU35480144
	168"	IU18480168	IU24480168	IU29480168	IU35480168
	180"	IU18480180	IU24480180	IU29480180	IU35480180
	192"	IU18480192	IU24480192	IU29480192	IU35480192
	240"	IU18480240	IU24480240	IU29480240	IU35480240
	288"	-	IU24480288	IU29480288	IU35480288

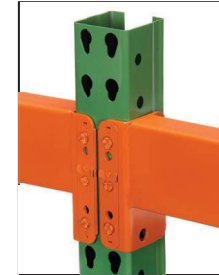
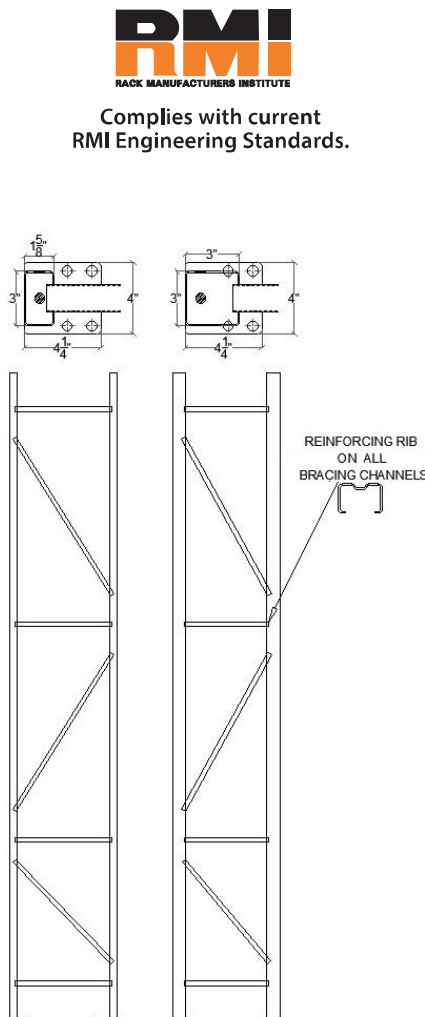

Invincible's teardrop pattern conforms to industry standards. Beams feature the patented Bowlock® safety clip, which installs automatically to prevent dislodgement. Many standard sizes are available and can ship within 48 hours.



- Uniform distribution of weight is assumed along the entire length of both beams
- Capacities based on L/180 deflection criteria
- Beams over 116" in length should be tied across the middle to prevent beam spreading
- Beams over 90" in length that support loose deck (wood), should be tied across the middle to prevent beam spreading

IBX = 16 GA
IBN = 14 GA
IBH = 13 GA

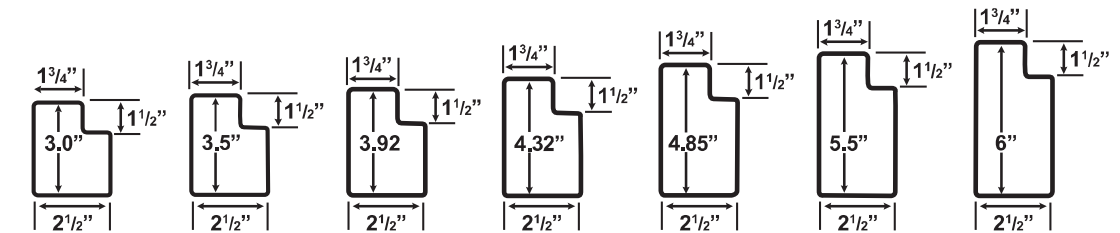

CAPACITY PER PAIR

BEAM SIZE	48"	60"	72"	84"	92"	96"	108"	120"	144"	LONGER BEAM OPTION
3.0"	IBX-30048 6,840#	IBX-30060 5,680#	IBX-30072 4,900#	IBX-30084 4,010#	IBX-30092 3,430#	IBX-30096 3,190#	IBX-30108 2,610#	IBX-30120 2,190#	IBX-30144 1,610#	CALL
3.5"	IBX-35048 8,180#	IBX-35060 6,740#	IBX-35072 5,780#	IBX-35084 5,090#	IBX-35092 4,520#	IBX-35096 4,190#	IBX-35108 3,410#	IBX-35120 2,840#	IBX-35144 2,080#	CALL
3.92"	IBX-39048 9,440#	IBX-39060 7,740#	IBX-39072 6,600#	IBX-39084 5,790#	IBX-39092 5,350#	IBX-39096 5,210#	IBX-39108 4,220#	IBX-39120 3,500#	IBX-39144 2,540#	CALL
4.32"	IBX-43048 10,670#	IBX-43060 8,720#	IBX-43072 7,400#	IBX-43084 6,460#	IBX-43092 5,980#	IBX-43096 6,270#	IBX-43108 5,060#	IBX-43120 4,190#	IBX-43144 3,020#	CALL
4.85"	IBX-48048 12,590#	IBX-48060 10,240#	IBX-48072 8,660#	IBX-48084 7,540#	IBX-48092 6,950#	IBX-48096 7,430#	IBX-48108 6,510#	IBX-48120 5,360#	IBX-48144 3,840#	CALL
4.85"	IBN-48048 14,610#	IBN-48060 11,850#	IBN-48072 10,010#	IBN-48084 8,700#	IBN-48092 8,010#	IBN-48096 8,560#	IBN-48108 7,380#	IBN-48120 6,060#	IBN-48144 4,330#	CALL
5.5"	IBN-55048 17,560#	IBN-55060 14,190#	IBN-55072 11,950#	IBN-55084 10,340#	IBN-55092 9,520#	IBN-55096 10,150#	IBN-55108 9,100#	IBN-55120 8,000#	IBN-55144 5,680#	CALL
6.0"	IBN-60048 20,010#	IBN-60060 16,140#	IBN-60072 13,560#	IBN-60084 11,730#	IBN-60092 10,760#	IBN-60096 11,480#	IBN-60108 10,280#	IBN-60120 9,330#	IBN-60144 6,910#	CALL
6.0"	IBH-60048 24,760#	IBH-60060 19,950#	IBH-60072 16,750#	IBH-60084 14,460#	IBH-60092 13,260#	IBH-60096 14,130#	IBH-60108 12,650#	IBH-60120 11,460#	IBH-60144 8,300#	CALL